

Stabilized Construction Entrance/Exit TC-1

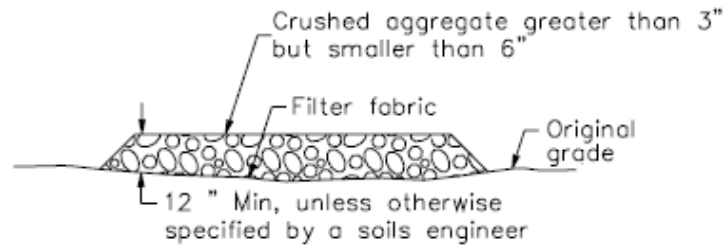

SECTION B-B
NTS

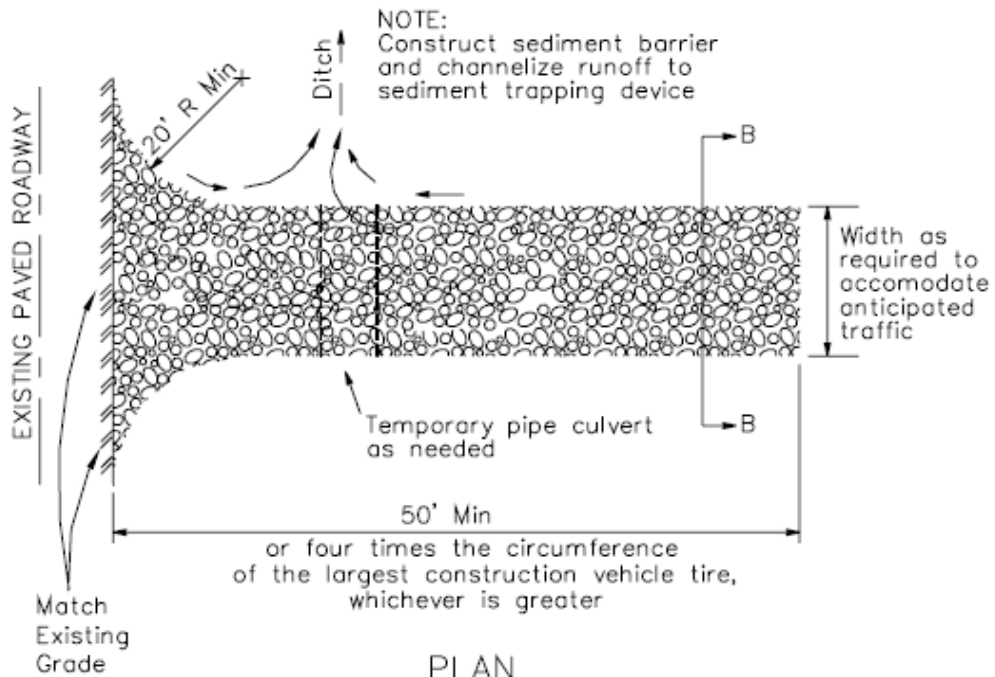

PLAN
NTS

Stabilized Construction Entrance/Exit TC-1

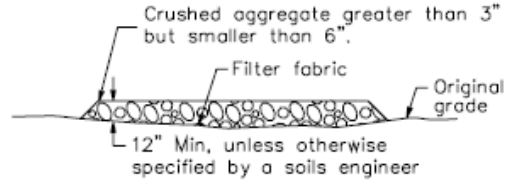

SECTION B-B
NTS

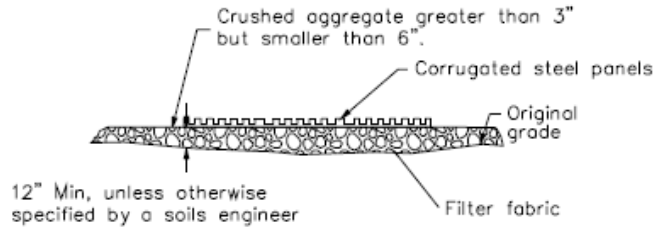

SECTION A-A
NOT TO SCALE

NOTE:
Construct sediment barrier and channelize runoff to sediment trapping device

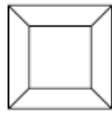

Sediment trapping device

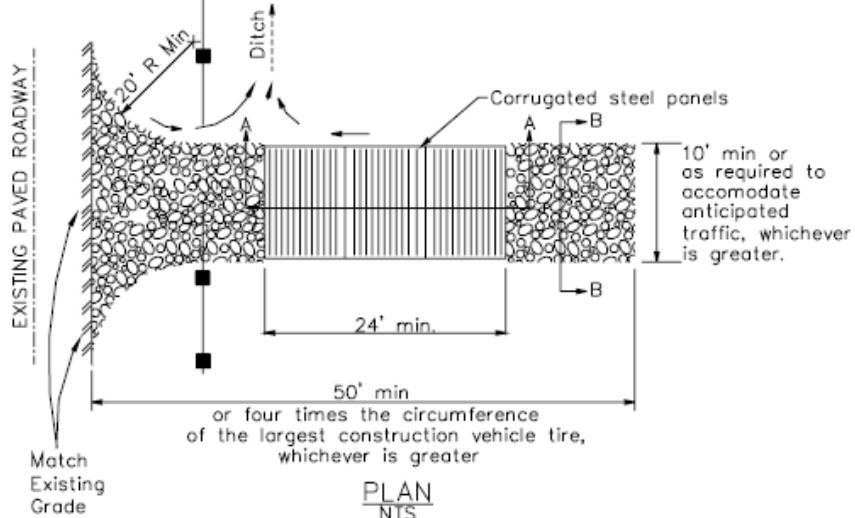

Entrance/Outlet Tire Wash

TC-3

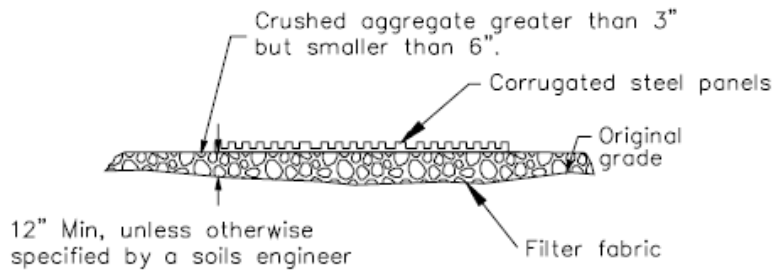

SECTION A-A
NOT TO SCALE

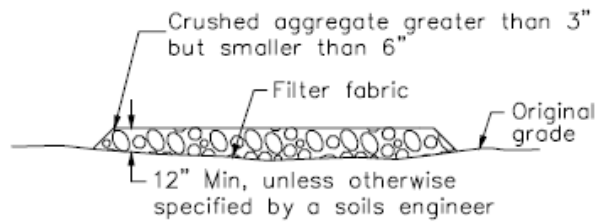

SECTION B-B
NTS

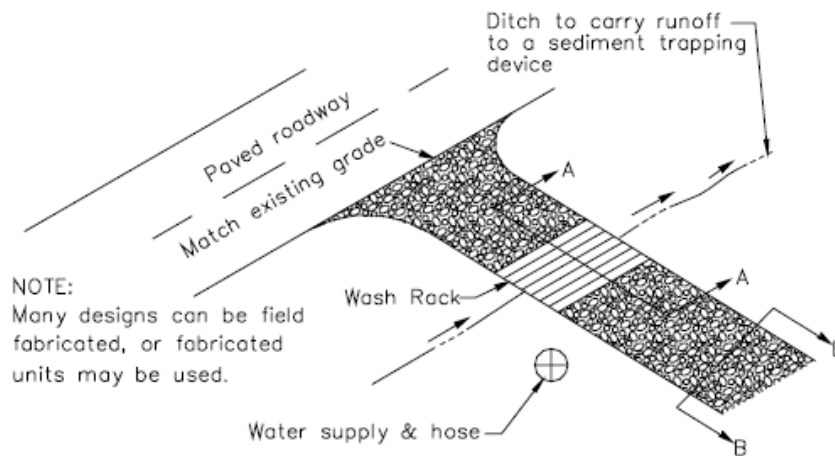

TYPICAL TIRE WASH
NOT TO SCALE